

Distribuidor BZD-BZV 150

BZD-BZV 150 Tipping Valve

Descripción Description

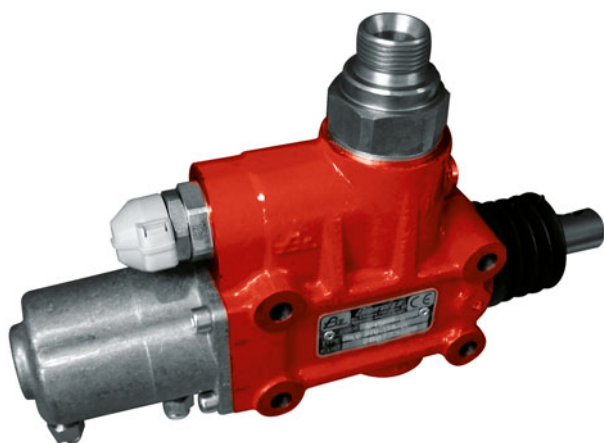

Válvula para volquete, centro abierto proporcional o centro cerrado de dos velocidades de bajada de 150 litros con accionamiento neumático, con válvula limitadora de presión ajustable hasta 350 bar. Incorpora válvula antirretorno, final de carrera mediante tirador o pulsador, presostato de funcionamiento opcional y toma de presión.

150 litres proportional open circuit or close circuit tipping valve, pneumatic operated, with 350 bar relief valve. It also includes check valve, pull-push end of stroke, pressure switch as option and pressure connection port.

Datos Principales Main Data

Modelo Model	BZDP 150 (Tirador / Pull)	BZDP 150 (Empujador / Push)	BZV 150-2V (Empujador / Push)	BZV 150-2V (Tirador / Pull)	BZVP 150 (Empujador-Tirador) (Push-Pull)
Codigo Part Number	9044190/3	9041890/3	9045190/3	9045090/3	9045290/3
Caudal de entrada Input Flow	100 L.				
Caudal de bajada Low Flow	150 L.				
Presión máx. Max. pressure	350 Bar				
Rosca Thread	1" BSP				
Peso Weight (Kg)	5.40				

Esquemas hidráulicos Hydraulic Diagrams

BZDP 150
9041890/3 9044190/3
(Empujador / Push) (Tirador/Puller)

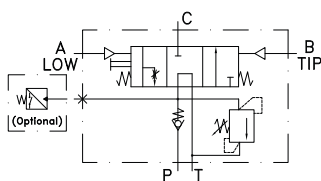

BZV 150 -2V
9045090/3 9045190/3
(Tirador / Pull) (Empujador/ Push)

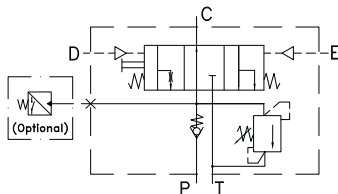

BZVP 150
9045290/3
(Tirador-Empujador / Push-Pull)

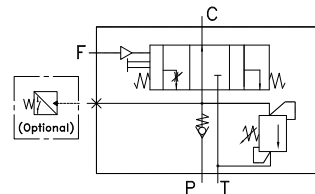

(*) Ver notas See notes

Distribuidor BZD-BZV 150

BZD-BZV 150 Tipping Valve

BZDP 150 (9041890/3) Empujador /Pull

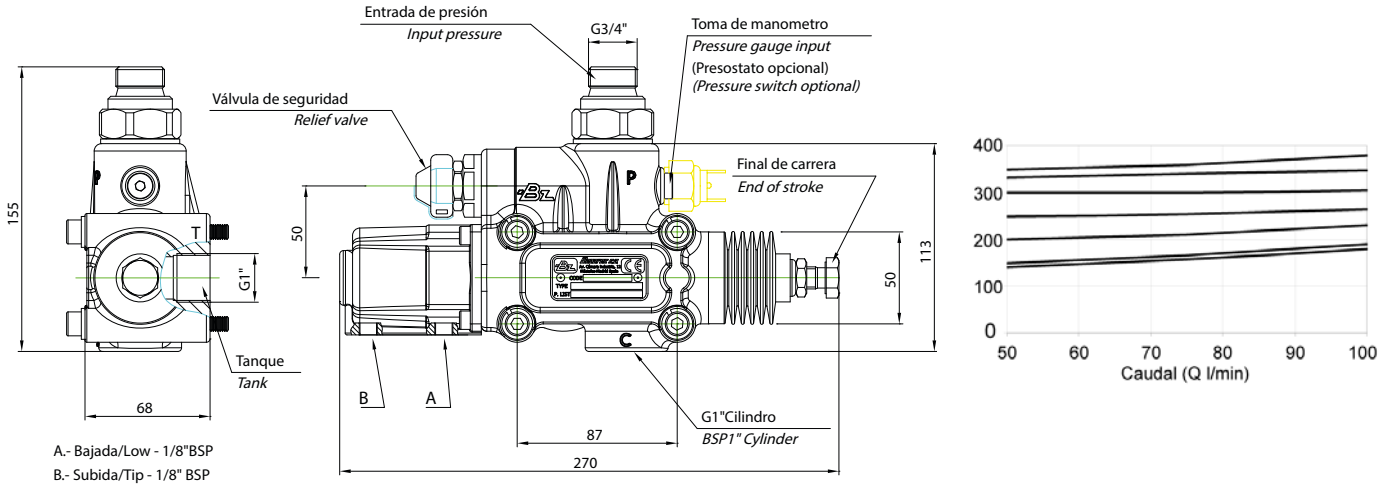

BZDP 150 Tirador/Pull (9044190/3)

BZV 150 - 2V (9045090/3)

BZVP 150 (9045290/3)

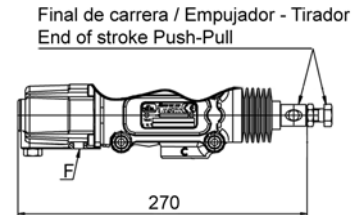
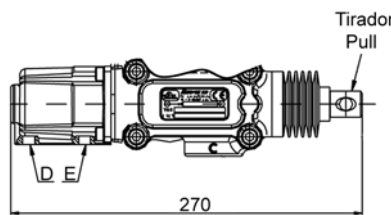
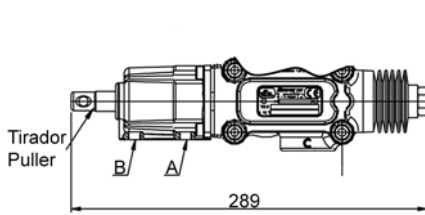

BZV-2V 150 Empujador/Push (9045190/3)

Opcional Codigo: 9043690 Optional Part Number: 9043690

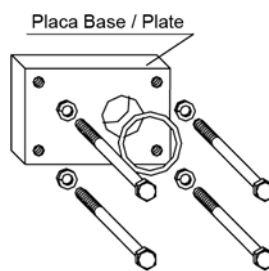
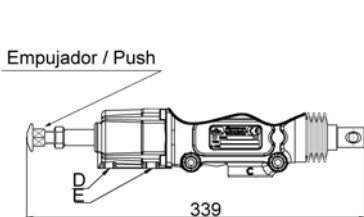

Importante:
 Par de apriete max. para tornillos placa base: 20 Nm
 Important:
 Max. torque wrench for base plate screws: 20 Nm

Notas Notes

A	Bajada 1/8" GAS	A	Low 1/8" BSP
B	Subida 1/8" GAS	B	Tipping 1/8" BSP
D	Bajada rápida 1/8" GAS	D	Rapid 1/8" BSP
E	Bajada lenta 1/8" GAS	E	Slow 1/8" BSP
F	Bajada proporcional 1/8" GAS	F	Proportional Lowering 1/8" BSP